

YWA-A-CP-139.8

(φ100 両面 かぶせ式)

設置図
S=1:10

詳細図
S=1:4

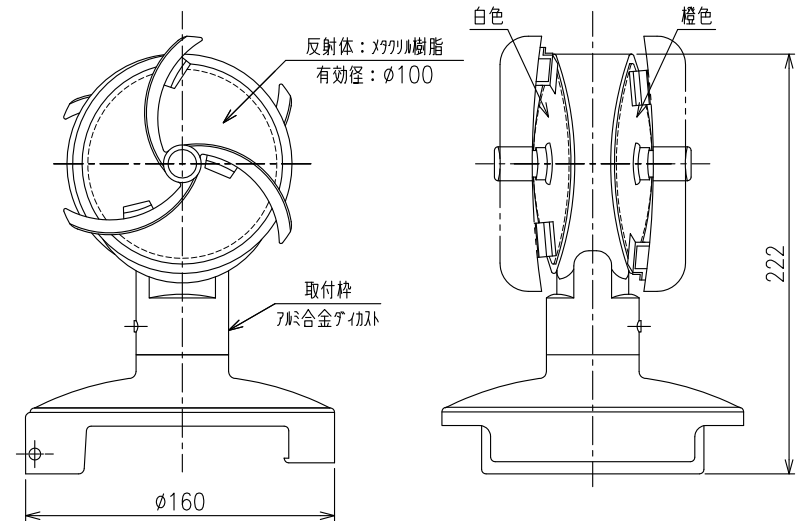
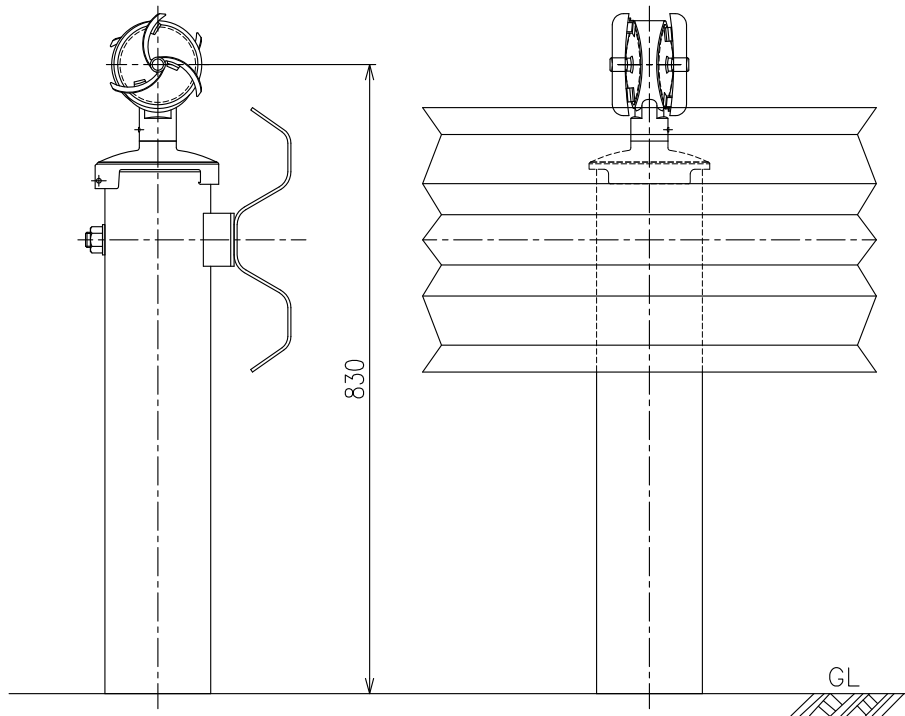

(重量: 0.8kg)