

# YWPA-A-CP-114.3

(φ100 平行 かぶせ式)

設置図  
S=1:10

詳細図  
S=1:4

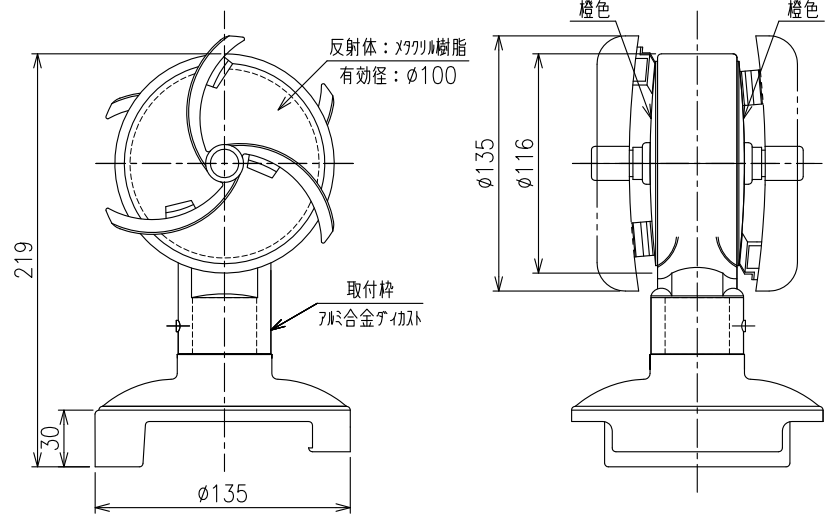
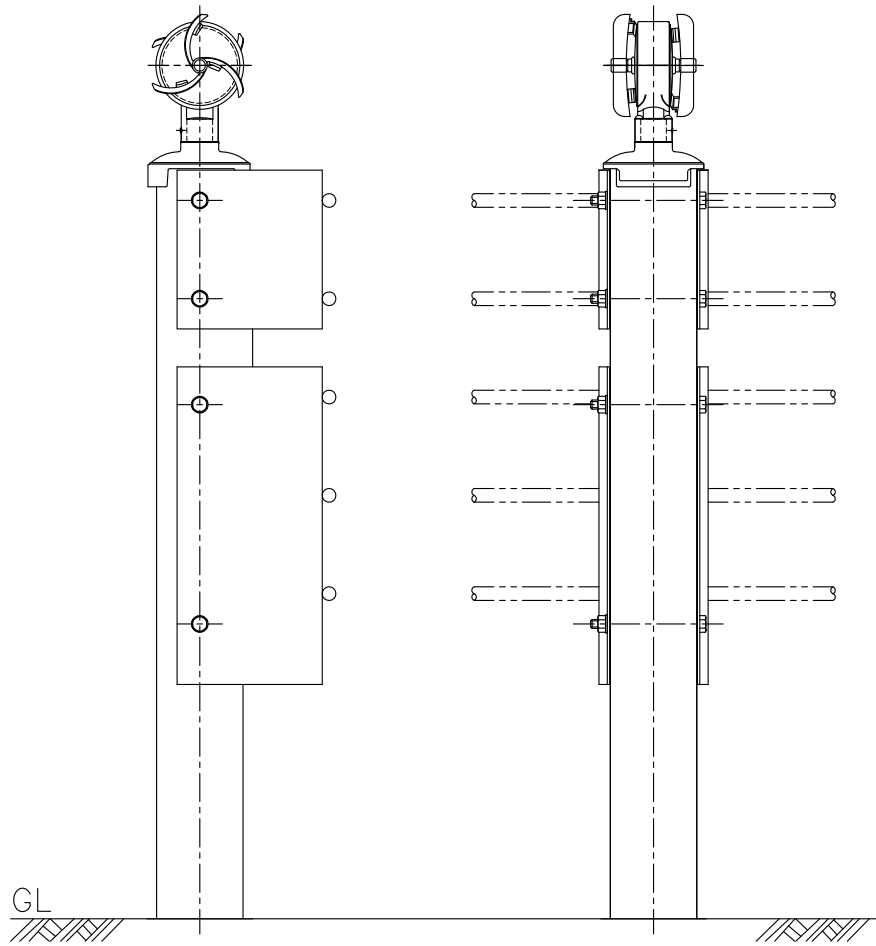

(重量: 0.7kg)