

1500VA



SPECIFICATIONS

FREQUENCY	50/60Hz	
INPUT VOLTAGE	AC100V	AC230V
OUTPUT VOLTAGE	AC100V×2 AC230V×1	AC100V×2 AC230V×1
RATED CAPACITY	TOTAL (3 OUTLETS) 1500 VA	
DIMENSIONS	W225×H128×D170mm	
CORD LENGTH	Approx. 1.2 m	
PRODUCT WEIGHT	5.8kg±0.25kg	

FEATURES

- This product can be used in Japan and other countries with voltages of 220-240V to power electrical appliances up to 1500VA.
- The multi-outlet design includes two 100V outlets and one 230V outlet, regardless of input voltage.
- Thermal protector automatically shuts off output in the event of abnormal heat generation.
- The circuit breaker activates in the event of an overcurrent, protecting the product from abnormal current.
- Soft-start circuit included.



USER MANUAL

● Safety precautions



Thank you for purchasing our product. Please be sure to read the instruction manual before use and use the product correctly. The precautions listed here are intended to ensure safe and correct use of the product and to prevent injury or damage to the user or other people.

- Before using an electrical appliance, check its power consumption (W) and use it within its maximum rated capacity (VA).
- The shape of power plugs for electrical appliances overseas and the shape of outlets vary depending on the region.
- Lighting fixtures, motors, and heat-generating electrical appliances may have an initial current that is 2 to 3 times the rated current.
- When using such equipment, use the appliance at no more than 1/3 of the rated current.
- If the outlet shape is different, please use a conversion plug.
- In Japan, some regions use 50Hz and some regions use 60Hz.
- Please note that electrical appliances overseas may not work if the frequency is incompatible.
We assume no responsibility for data loss from devices used with this product. Be sure to back up all data before use.
- We assume no responsibility or liability for accidents, malfunctions, or damage resulting from natural disasters such as lightning strikes, or from improper installation or modification of this product.
- Cautions are categorized as follows. All precautions contain important safety information and must be followed.



EXPLANATION OF NOTATION

 WARNING	This symbol indicates the possibility of death or serious injury.
 CAUTION	This symbol indicates the possibility of personal injury or property damage.

EXPLANATION OF SYMBOLS

	This symbol indicates something that must be done.
	This symbol indicates something that you must not do.

WARNING

	After use, always unplug the power cord of this product from the outlet. Failure to do so may cause fire or accidents.
	Use this product with a dedicated wall outlet. Using it together with other appliances may cause the branched outlet to overheat and potentially catch fire.
	Make sure the power plug of this product is fully inserted into the outlet. Failure to do so may result in electric shock or fire caused by overheating.
	If dust has accumulated on this product's power plug, wipe it off thoroughly. Failure to do so may result in electric shock or fire caused by overheating.
	If smoke, a strange odor, unusual noise, or any other abnormality occurs from the unit, there is a risk of fire or electric shock, so unplug the power cord immediately.
	If electrical appliances or indoor outlets are faulty or damaged, this product may be damaged. Stop using it immediately.
	Do not operate the input voltage selector switch while the product is in use. Doing so may damage the connected device.
	Do not use this product for medical devices, life-support equipment, critical systems, uninterruptible power supplies, or any other applications requiring a high level of reliability.

⚠ WARNING



Do not use the product if the power cord or plug is damaged, or if the outlet connection is loose. This may result in electric shock, short circuit, or fire.

Do not damage, bend, pull, twist, place heavy objects on, pinch, or modify the power cord of this product.



Do not immerse in or pour water on the product. This may cause a short circuit or electric shock.



Do not disassemble, repair, or modify the product under any circumstances. This may cause fire, electric shock, or injury.

⚠ CAUTION



When unplugging this product's power plug from the outlet, always hold the plug itself. Failure to do so may cause electric shock or a short circuit that could lead to fire.

When not in use, unplug the power cord from the outlet. Failure to do so may result in injury, burns, electric shock, or fire due to insulation deterioration or leakage.

When moving the product, hold it securely with both hands.

Avoid placing the product in hot or humid locations. Keep it in a cool, well-ventilated indoor area.



Do not use the product if it has been dropped or struck. This may cause electric shock or fire.

Do not use the product in countries with voltages other than 100V or 220–240V. Failure to do so may cause malfunction or accidents.

Do not repeatedly turn this product's power switch on and off in a short period of time.

After use, this product's case may become hot. Do not touch it.

※ INRUSH CURRENT

Due to the characteristics of the transformer, the breaker may trip temporarily when the power plug is inserted into the outlet, depending on the instantaneous current, breaker capacity, and sensitivity. Please be careful if the breaker capacity in hotel rooms or residences is low.

PART NAMES

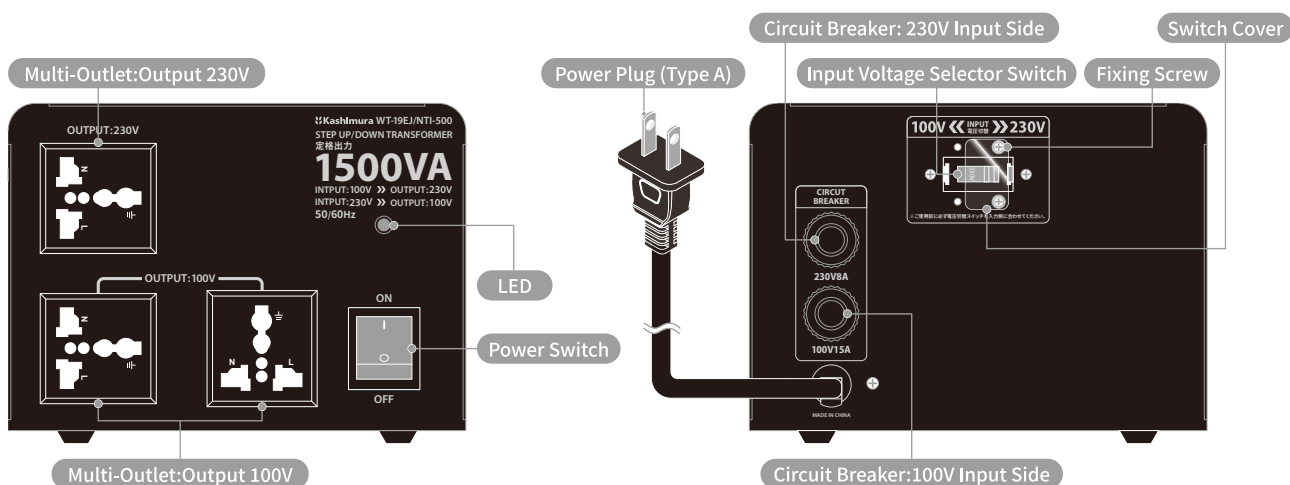

LIST OF SUPPORTED PLUGS



IEC STANDARDS	A	B	C	D	E/F	G	H	I	J	L	N	O
COMMON NAME	A	A3	C	B3	SE	BF	-	O/O2	-	-	CB	-

HOW TO USE

1. Before use, always make sure that the "Input Voltage Selector Switch" is set to the voltage of the country where the product will be used.

※ The initial position of the "Input Voltage Selector Switch" is 230V, so it must be changed when using the product in Japan.

※ A screwdriver is required to change the input voltage.

● HOW TO CHANGE THE VOLTAGE

- ① Remove the "Fixing Screw".
- ② Remove the "Switch Cover".
- ③ Slide the "Input Voltage Selector Switch" to the voltage you will use.
- ④ Secure the "Switch Cover" on the selected voltage side with the "Fixing Screw".

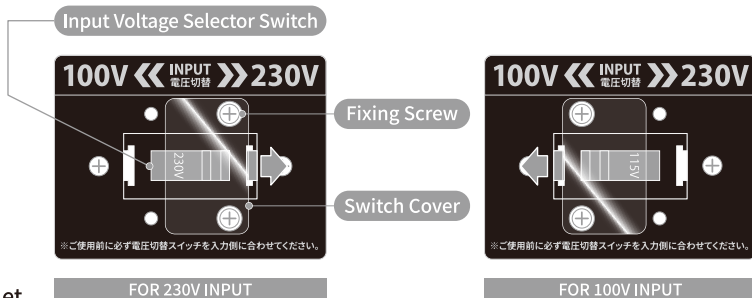

2. Insert the product's "Power Plug" into a wall outlet.

If the outlet type is not Type A, use an appropriate plug adapter.

3. Connect the device you will use to the "Multi-Outlet" set to the correct output voltage.

Check the "List of Supported Plugs" for compatible plugs. If your plug is not supported, use a plug adapter.

4. Press the "Power Switch" to the ON position. The "LED" will light up.

5. After use, press the "Power Switch" to the OFF position and unplug the "Power Plug" from the outlet.

PROTECTION FEATURES

● THERMAL PROTECTOR

If the internal temperature of this product rises abnormally, the protection device will automatically activate and shut off the output. In that case, turn off the power and wait until the product cools down (approximately 30 minutes). After the product has cooled down, it can be used again.

● CIRCUIT BREAKER

If an excessive current flows, the "Circuit Breaker" will activate and stop the output.

To resume output, press the "Circuit Breaker" button that has popped out due to the protective operation.

※ If the thermal protector or circuit breaker of this product is activated repeatedly, discontinue use immediately.

※ When using this product continuously for more than one hour, do not exceed 80% of the maximum rated capacity (1200 VA).

※ Depending on the characteristics of the connected equipment (such as low power factor or harmonic distortion) and fluctuations in the power supply voltage, the circuit breaker may trip even at loads of 80% or less.

OVERSEAS ELECTRICAL CONDITIONS

※ The bathroom outlet may be designed for low-current devices such as electric shavers. In that case, use an outlet in another room.

※ Some outlets have a switch next to them, and power will not flow unless the switch is turned ON.

WARRANTY CARD

PRODUCT NUMBER	WT-19EJ/NTI-500		
PRODUCT NAME	LARGE TRANSFORMER FOR DOMESTIC AND OVERSEAS USE 100V/220-240V/1500VA		
PURCHASE DATE	YEAR:	MONTH:	DAY:
WARRANTY PERIOD	1 YEAR FROM THE DATE OF PURCHASE		
CUSTOMER	ADDRESS		
	NAME		
	TEL		
DESCRIPTION OF THE PROBLEM			
RECEIPT ATTACHMENT AREA Please be sure to attach the receipt from the store where the product was purchased. If the receipt is not provided, the product will not be eligible for free repair.			

【WARRANTY TERMS】

- Our company does not provide on-site repair services for safety management and quality assurance reasons. All products must be inspected and repaired under controlled conditions. Therefore, if you require repair, the product must be sent to us using the designated method. Please note that walk-in service is not accepted.
- If a product fails under normal use (following the instructions in the user manual and warnings on the product label) during the warranty period, we will repair it free of charge using our designated method.
- At our discretion, we may replace the product instead of repairing it.
- To receive free repair during the warranty period, bring the product along with the warranty card and the purchase receipt to the retailer where it was purchased.
- Repairs will be chargeable under the following conditions, even within the warranty period:
 1. If the warranty card and receipt (with purchase date clearly indicated) cannot be presented.
 2. If the required fields on the warranty card are incomplete or altered.
 3. Failures or damage caused by misuse, interference from other devices, or unauthorized repair or modification.
 4. Failures or damage caused by relocation, transportation, or dropping of the product after purchase.
 5. Failures or damage caused by fire, earthquake, wind or water damage, lightning, other natural disasters, pollution, salt damage, abnormal voltage, or similar external factors.
 6. Failures or damage resulting from use outside of general household environments (e.g., commercial or industrial use).
 7. Replacement of consumable or worn parts.
- Repairs are not covered if we determine that the product has been modified or repaired by the customer.
- Our company is not responsible for any direct or indirect damage caused by the product or its use.
- This warranty is valid only in Japan.
- This warranty cannot be reissued, so please keep it in a safe place.



■ CUSTOMER SUPPORT
 Official Website: <https://www.kashimura.com>
TEL : 050-3199-2558
 (Weekdays only 10:00-12:00/13:00-17:00)
 Address: 6-9-28 Ayase, Adachi-ku, Tokyo
 120-0005 Japan



※ Company names and product names mentioned herein are trademarks or registered trademarks of their respective companies.

※ The design and specifications of this product are subject to change without prior notice.

※ When disposing of this product, please follow the waste disposal regulations of your local municipality.

※ This product was planned and designed by Kashimura Co., Ltd. and manufactured in China.